

2016 // PROFESSIONAL-GRADE ILLUMINATION TOOLS



SHATTER
THE DARK.



STREAMLIGHT, THE WIDEST ARRAY OF WEAPON-MOUNTED LIGHTS.

At Streamlight, we engineer the highest performing, most rugged, durable and innovative lights on the market. We create lights that add real value... for specific tasks as well as for a wide variety of applications – including the widest array of weapon mounted lights. Whether you're LED, S.W.A.T., Military, home defense or a sportsman, Streamlight builds the products you can depend on and the options and configurations that you need.

In developing lights that help our customers work more efficiently, safely, and economically, we've changed the shape of the flashlight industry. And we've literally changed the shape of illumination. Streamlight's cutting edge beam patterns, like our HL and HPL lights, have set new standards, and demonstrated just how practical advanced design can be.



NON-RECHARGEABLE

PROTAC WEAPON-MOUNTED SERIES
// STREAMLIGHT 2016

THE NEW PROTAC RAIL MOUNT LIGHTS

SHATTER THE DARK
WITHOUT BREAKING THE BANK.

PROTAC® RAIL MOUNT 2

The ProTac series expands into weapon-mounted lights with this 625 lumen light featuring a dedicated fixed-mount for Picatinny rails. Lightweight, this bright light can be used in close quarter combat or to identify medium range threats. Rugged, reliable. Its easy to use pressure switch comes with a button for on/off and a pressure switch for momentary activation. TEN-TAP® programming provide operator custom options.

PROTAC RAIL MOUNT 2

BATTERY: (2) 3V "CR123A" lithium

SIZE: 5.00" x 1.50" x 1.20"
(12.7 x 3.81 x 3.04 cm)

WEIGHT: 5.00 oz (141.7 g)

COLOR: Black

88059 with (2) lithium batteries-Black

| CR123 | HIGH | LOW |
|------------------|--------|-------|
| LUMENS: | 625 | 60 |
| CANDELA: | 22,000 | 2,000 |
| DISTANCE: | 297m | 89m |
| RUN TIME: | 1h 30m | 18h |

Strobe runs 2.75 hours

TEN-TAP® programmable switch allows user selection of one of three different programs:

- high/strobe (factory default)
- high only
- low/high



An additional tail cap switch is included in each Rail Mount package if the remote switch is not preferred.



NEW FOR 2016
625 LUMENS

PROTAC® RAIL MOUNT 1

The ProTac series expands into weapon-mounted lights with this 350 lumen light featuring a dedicated fixed-mount for Picatinny rails. It uses either a remote switch with momentary/constant on operation or a standard push-button tail switch, and can run on either a lithium battery or an easy-to-find alkaline battery.

PROTAC RAIL MOUNT 1

BATTERY: (1) 3V "CR123A" lithium or (1) "AA" Alkaline

SIZE: 4.25" x 1.50" x 1.20"
(10.8 x 3.81 x 3.04 cm)

WEIGHT: 4.3 oz (121.9 g) w/CR123

COLOR: Black

88058 with (1) lithium battery-Black

| CR123 | HIGH | LOW |
|------------------|--------|---------|
| LUMENS: | 350 | 40 |
| CANDELA: | 12,000 | 1,380 |
| DISTANCE: | 219m | 19m |
| RUN TIME: | 1h 45m | 14h 30m |

Strobe runs 2.75 hours

DUAL FUEL DESIGN:

Runs on one "AA" alkaline or CR123A lithium battery – both included.

| ALKALINE | HIGH | LOW |
|------------------|--------|-------|
| LUMENS: | 150 | 40 |
| CANDELA: | 4,950 | 1,380 |
| DISTANCE: | 141m | 19m |
| RUN TIME: | 1h 30m | 8h |

Strobe runs 2.75 hours



TEN-TAP® programmable switch allows user selection of one of three different programs:

- high/strobe (factory default)
- high only
- low/high



NEW FOR 2016
350 LUMENS

NON-RECHARGEABLE

PROTAC SERIES
// STREAMLIGHT 2016

NEED HIGH LUMEN PERFORMANCE? CHOOSE FROM THE PROTAC HL FAMILY. INCLUDING THE NEW 2,200 LUMEN PROTAC HL® 4

PROTAC HL®4

With 2,200 lumens of blinding light, the ProTac HL®4 is the newest and brightest addition to the ProTac® series. It offers the latest in power LED technology and three different userselectable programs. The output from the C4® LED results in one of the brightest tactical lights available. The "sure grip rubber sleeve" and included lanyard ensures you'll never lose your grip

PROTAC HL 4

BATTERY: (4) 3V "CR123A" lithium or (2) 18650 Li-Ion 3.7v 2600mAh rechargeables

SIZE: 8.63" x 2.35" x 1.24" (21.92 x 5.97 x 3.15 cm)

WEIGHT: 17 oz (482 g)

COLOR: Black

88060 with lithium batteries and holster-Black

| WITH 18650 | HIGH | MEDIUM | LOW |
|------------------|--------|--------|-----|
| LUMENS: | 2,200 | 600 | 60 |
| CANDELA: | 30,000 | 8,300 | 800 |
| DISTANCE: | 346m | 182m | 56m |
| RUN TIME: | 1h 30m | 4h | 40h |

Strobe runs 2.75 hours

| WITH 18650 | HIGH | MEDIUM | LOW |
|------------------|--------|--------|-----|
| LUMENS: | 2,200 | 600 | 60 |
| CANDELA: | 30,000 | 8,300 | 800 |
| DISTANCE: | 346m | 182m | 56m |
| RUN TIME: | 1h 45m | 4h 15m | 43h |

Strobe runs 2.75 hours



HL SERIES

DUAL FUEL DESIGN:
Runs on CR123 or 18650 batteries

TEN-TAP® programmable switch allows user selection of one of three different programs:

- high/strobe/low (factory default)
- high only
- low/med/high

NEW FOR 2016
2,200 LUMENS

HL **C4** LED With **[(STROBE)]**
Double tap switch to activate.

18650 LI-ION BATTERIES AND CHARGER

The 18650 Li-Ion batteries provides an alternate power source for newer Streamlight products that accept either standard CR123A lithium batteries or 18650 batteries. The two bay 18650 battery charger can recharge one 18650 battery in as little as 3.5 hours, or two batteries in as little as 6.5 hours. The charger features dual input power sources, accepting either 5V USB power or 12VDC power. Dual input power sources provide a wide variety of battery charging options when a wall outlet is not available, such as a PC, power pack or 12VDC automotive power. Models available with charger, two 18650 batteries and either a 120V AC/micro-USB adapter or custom micro-USB cord, depending on model.

22010 18650 Charger Kit - USB (includes two 18650 batteries)

22011 18650 Charger Kit - 120V AC (includes two 18650 batteries)

18650 LI-ION BATTERY AND CHARGER

BATTERY: 3.7V, 2600mAh, rechargeable

CHARGER SIZE: 4.5" x 2.0" x 1.45"
(11.4 x 5.1 x 3.7cm)

CHARGER WEIGHT: 2.4 oz (68 g)

NEW FOR 2016



Individual bay LED display for battery charge status.

Two bay design with single bay priority speeds charging when used with single battery products.

Charger temperature safety circuit prevents damage to batteries while charging.

PROTAC HL® 3

HL SERIES

| | HIGH | LOW |
|-----------|--------|-------|
| LUMENS: | 1,100 | 35 |
| CANDELA: | 36,000 | 1,200 |
| DISTANCE: | 379m | 69m |
| RUN TIME: | 2h | 43h |

Strobe runs 2 hours



TEN-TAP® programmable switch allows user selection of one of three different programs:

- high/strobe/low (factory default)
- high only
- low/high

1,100 LUMENS

New technology allows us to put 1,100 lumens in the palm of your hands with a wide beam pattern that illuminates an entire area. TEN-TAP® programming lets you choose the order of operating modes (high, low, strobe). IPX7-rated waterproof to 1 meter/30 minutes. 1 meter impact-resistance tested.

PROTAC HL 3
BATTERY: (3) 3V "CR123A" lithium
SIZE: 7.1" x 1.73" x 1.0"
 (18.03 x 4.39 x 2.54 cm)
WEIGHT: 9.3 oz (263 g)
COLOR: Black

88047 with lithium batteries and holster-Black

PROTAC HL®

HL SERIES

| | HIGH | LOW |
|-----------|--------|-----|
| LUMENS: | 750 | 35 |
| CANDELA: | 18,300 | 900 |
| DISTANCE: | 270m | 60m |
| RUN TIME: | 1h 15m | 18h |

Strobe runs 2.5 hours



TEN-TAP® programmable switch allows user selection of one of three different programs:

- high/strobe/low (factory default)
- high only
- low/high

750 LUMENS



One of the brightest tactical personal carry lights of its size. Far-reaching beam. TEN-TAP® programming lets you choose the order of operating modes (high, strobe, low). IPX7-rated waterproof to 1 meter/30 minutes. 1 meter impact-resistance tested.

PROTAC HL
BATTERY: (2) 3V "CR123A" lithium
SIZE: 5.4" x 1.375" x 1.0"
 (13.72 x 3.49 x 2.54 cm)
WEIGHT: 5.6 oz (158 g)
COLOR: Black

88040 with lithium batteries and holster-Black
 88043 Holster

PROTAC HL® USB

HL SERIES

| | HIGH | MEDIUM | LOW |
|-----------|--------|--------|-------|
| LUMENS: | 850 | 350 | 85 |
| CANDELA: | 10,000 | 4,000 | 1,000 |
| DISTANCE: | 200m | 126m | 63m |
| RUN TIME: | 1h 30m | 4h | 12h |

Strobe runs 1.5 hours



TEN-TAP® programmable switch allows user selection of one of three different programs:

- high/strobe/low (factory default)
- high only
- low/medium/high

Recharge by plugging into USB port or optional AC wall adapter



850 LUMENS



The ProTac HL USB is incredibly bright and features new multiple power source capability. It uses our lithium ion rechargeable battery, CR123A batteries or an available Li-On 18650 rechargeable battery. It recharges by connecting to a USB port, so it's easy to charge on the go. Anti-rattle battery compartment keeps batteries securely and quietly in place and doesn't need a battery carrier. TEN-TAP® programming lets you choose the selection of operating modes (high/strobe/low, high only or low/medium/high). IPX4 rated for water resistance.

PROTAC HL USB
BATTERY: Lithium-ion, Lithium-ion 18650 or (2) 3V "CR123A" lithium
SIZE: 6.5" x 1.23" x 1.07"
 (16.5 x 3.1 x 2.7 cm)
WEIGHT: 7.2 oz (204 g) with Li-On battery
COLOR: Black

88052 with USB Cord and holster-Black
 88054 with USB 120V/DC and holster-Black

NON-RECHARGEABLE

PROTAC SERIES
// STREAMLIGHT 2016

THE PROTAC SERIES... **SMALLEST,**



PROTAC® 1L PROTAC® 2L

Nylon
Holster

| | HIGH | LOW |
|-----------|-------|-----|
| LUMENS: | 180 | 12 |
| CANDELA: | 3,800 | 250 |
| DISTANCE: | 123m | 32m |
| RUN TIME: | 2h | 24h |

Strobe runs 4 hours

| | HIGH | LOW |
|-----------|-------|-----|
| LUMENS: | 260 | 13 |
| CANDELA: | 5,600 | 300 |
| DISTANCE: | 150m | 35m |
| RUN TIME: | 3h | 50h |

Strobe runs 6 hours

C4 LED With **[(STROBE)]**
Double tap switch to activate.



PROTAC® 1AA PROTAC® 2AA

Nylon
Holster

| | HIGH | LOW |
|-----------|-------|-----|
| LUMENS: | 70 | 5 |
| CANDELA: | 1,450 | 125 |
| DISTANCE: | 76m | 22m |
| RUN TIME: | 2h | 32h |

Strobe runs 4 hours

| | HIGH | LOW |
|-----------|-------|-----|
| LUMENS: | 155 | 11 |
| CANDELA: | 3,300 | 200 |
| DISTANCE: | 115m | 28m |
| RUN TIME: | 2h | 36h |

Strobe runs 4 hours

C4 LED With **[(STROBE)]**
Double tap switch to activate.



They're both compact and lightweight, yet powerful, bright, with long run times and lots of important features. TEN-TAP® programming for user selection of mode programs (high, low, strobe). IPX7 waterproof to 1 meter for 30 minutes. 2 meter impact resistance tested. Maximum light output throughout battery life.

PROTAC 1L
BATTERY: (1) 3V "CR123A" lithium
SIZE: 3.43" x .9" x .77"
(8.71 x 2.29 x 1.96 cm)
WEIGHT: 2.0 oz (57 g)
COLOR: Black

PROTAC 2L
BATTERY: (2) 3V "CR123A" lithium
SIZE: 4.77" x .9" x .77"
(12.12 x 2.29 x 1.96 cm)
WEIGHT: 2.8 oz (79 g)
COLOR: Black

PROTAC® 1L
88030 with (1) lithium battery and holster - Black
88035 Holster

PROTAC® 2L
88031 with (2) lithium batteries and holster - Black
88036 Holster

Both models are small enough to carry in a pocket, lightweight, yet extremely bright. TEN-TAP® programming for user selection of mode programs (high, low, strobe). IPX7 waterproof to 1 meter for 30 minutes. 2 meter impact resistance tested. Maximum light output throughout battery life.

PROTAC 1AA
BATTERY: (1) "AA" alkaline or lithium
SIZE: 4.16" x .9" x .65"
(10.57 x 2.29 x 1.65 cm)
WEIGHT: 2.3 oz (65 g)
COLOR: Black

PROTAC 2AA
BATTERY: (2) "AA" alkaline or lithium
SIZE: 6.14" x .9" x .65"
(15.60 x 2.29 x 1.65 cm)
WEIGHT: 3.4 oz (96 g)
COLOR: Black

PROTAC® 1AA
88032 with (1) alkaline battery and holster - Black
88037 Holster

PROTAC® 2AA
88033 with (2) alkaline batteries and holster - Black
88038 Holster

LIGHTEST, HAND-HELD TACTICALS.

PROTAC® 1AAA

| LITHIUM | HIGH | LOW | ALKALINE | HIGH | LOW |
|-----------|--------|-----|-----------|------|-----|
| LUMENS: | 70 | 5 | LUMENS: | 70 | 5 |
| CANDELA: | 550 | 40 | CANDELA: | 550 | 40 |
| DISTANCE: | 47m | 13m | DISTANCE: | 47m | 13m |
| RUN TIME: | 2h 15m | 22h | RUN TIME: | 30m | 11h |

Strobe runs 5 hours

Strobe runs 1.2 hours

TEN-TAP® programmable switch allows user selection of one of three different programs:

- high/strobe/low (factory default)
- high only
- low/high



Compact & powerful, this ProTac® series flashlight offers three different user selectable programs and the latest in power LED technology. The combination of small size and output from the C4® LED result in one of the brightest tactical personal carry lights for its size. Packaged with a removable pocket clip and holster.

PROTAC 1AAA

BATTERY: (1) "AAA" alkaline or lithium

SIZE: 3.94" x .71" x .57"
(10.0 x 1.80 x 1.44 cm)

WEIGHT: 1.3 oz (37 g)

COLOR: Black

PROTAC® 1AAA

88049 with (1) alkaline battery and holster—Black

72024 Lanyard

PROTAC® 2AAA

| | HIGH | LOW |
|-----------|--------|-----|
| LUMENS: | 80 | 10 |
| CANDELA: | 1,550 | 200 |
| DISTANCE: | 80m | 28m |
| RUN TIME: | 1h 30m | 30h |

Strobe runs 5 hours



Lightweight personal flashlight with three modes (high, low, and strobe), a removable pocket clip and a 30-hr. run time on low. IPX7 waterproof to 1 meter for 30 minutes. Maximum light output throughout battery life.

PROTAC 2AAA

BATTERY: (2) "AAA" alkaline

SIZE: 5.62" x .72" x .5"
(14.27 x 1.83 x 1.27 cm)

WEIGHT: 2.0 oz (57 g)

COLOR: Black

PROTAC® 2AAA

88039 w/ (2) alkaline batteries—Black

88045 Holster

PROTAC HL® HEADLAMP

HL SERIES

| | HIGH | MEDIUM | LOW |
|-----------|--------|--------|-----|
| LUMENS: | 540 | 95 | 18 |
| CANDELA: | 7,400 | 1,200 | 250 |
| DISTANCE: | 172m | 69m | 31m |
| RUN TIME: | 1h 45m | 8h | 36h |

TEN-TAP® programmable switch allows user selection of one of three different programs:

- high/medium/low (factory default)
- high only
- low/medium/high



540 LUMENS



The perfect light for when your task requires both hands and a bright light with a wide, long-range beam. 90° tilting head reduces neck fatigue. TEN-TAP® programming lets you choose the order of operating modes (high, medium, low). IPX4-rated for water resistance. 1 meter impact-resistance tested. Maximum light output throughout battery life.

PROTAC HL HEADLAMP

BATTERY: (2) 3V "CR123A" lithium

SIZE: 3.66" x 1.2" x 2.6"
(9.30 x 3.05 x 6.60 cm)

WEIGHT: 6.6 oz (187 g)

COLOR: Black

PROTAC HL® HEADLAMP

61304 with lithium batteries—rubber and elastic straps—Black

NON-RECHARGEABLE

TACTICAL SUB-COMPACT WEAPON-MOUNTED SERIES
// STREAMLIGHT 2016



STREAMLIGHT TLR-6

PERFECTLY BALANCED
PERFECTLY INTEGRATED.

TLR-6®

An industry first, the ultra-compact TLR-6® weapon light with C4® LED and integrated red aiming laser features tool-less battery replacement without removal from the weapon or the need to re-sight the laser. The light provides 1 hour of regulated runtime when in dual light/laser mode. Designed to securely attach to the trigger guard of the subcompact pistols. Durable, impact-resistant polymer construction; IPX4 water-resistant. 1 meter impact resistance tested.

TLR-6

BATTERY: (2) 3V CR-1/3 N lithium

SIZE:* 2.30" x .085" x 1.42"
(5.84 x 2.16 x 3.61 cm)

WEIGHT:* 1.27 oz (36 g)

COLOR: Black or Flat Dark Earth Brown

| | |
|-------|---|
| 69270 | TLR-6 (Glock® 42/43) with lithium batteries-Black |
| 69278 | TLR-6 (Glock® 42/43) with lithium batteries-Flat Dark Earth Brown |
| 69272 | TLR-6 (Glock® 26/27/33) with lithium batteries-Black |
| 69273 | TLR-6 (M&P Shield™) 40/9 with lithium batteries-Black |
| 69274 | TLR-6 (Kahr®) with lithium batteries-Black |
| 69275 | TLR-6 (SIG SAUER® P238/P938) with lithium batteries-Black |
| 69276 | TLR-6 (Kimber® Micro) with lithium batteries-Black |
| 69277 | TLR-6 Combo Kit |

*Size & Weight vary by model. Glock® 42/43 listed.

| | |
|------------------|-------|
| LUMENS: | 100 |
| CANDELA: | 2,000 |
| RUN TIME: | 89m |
| RUN TIME: | 1h |

Laser mode: 11 hours of run time

100 LUMENS

NEW MODELS FOR 2016

Designed for use with the following weapons:

- Glock® 42, Glock® 43
- Glock® 26, Glock® 27, Glock® 33
- M&P Shield™ 40, M&P Shield™ 9
- Kahr® CT9, CT40, CW9, CW40, CM9, CM40, TP9, TP40, P9, P40, PM9, PM40
- SIG SAUER® P238, P938
- Kimber® Micro

All Rights Reserved. M&P Shield™, Glock®, SIG SAUER®, KIMBER®, & KAHR® are registered trademarks of Smith & Wesson, Glock®, Inc., SIG SAUER, KIMBER, IP LLC & Saeilo Enterprises, Inc. Streamlight has not sought endorsement of this product from Smith & Wesson®, Glock®, SIG SAUER®, KIMBER®, KAHR® Arms or Saeilo Enterprises, Inc.

WHITE LIGHT ILLUMINATOR // RED LASER



Available in Flat Dark Earth Brown for Glock® 42/43

COMPACT & SUB-COMPACT **OPTIONS** FOR **ULTRA-COMPACT LIGHTS**

TLR-3®

WHITE LIGHT ILLUMINATOR //

LUMENS: 125
CANDELA: 5,300
RUN TIME: 1h 30m



125 LUMENS

Lightweight and powerful, this super-bright light is designed for sub-compact and compact weapons, yet it fits the broadest array of handguns - up to full size. Operates in temperatures from -40°F to +120°F. IPX7-rated waterproof to 1 meter for 30 minutes.

TLR-3

BATTERY: (1) 3V "CR2" lithium

SIZE: 2.71" x 1.18" x 1.51"
(6.88 x 3 x 3.84 cm)

WEIGHT: 2.32 oz (65.8 g)

COLOR: Black

69220 Standard model includes rail locating keys for use with Picatinny or Glock® style rails. Lithium battery. Black.

69221 H&K USP Compact Model. Black.

69222 H&K USP Full-Size Model. Black.

TLR-4®

WHITE LIGHT ILLUMINATOR // RED LASER

LUMENS: 125
CANDELA: 5,300
RUN TIME: 1h 30m

Laser only mode: 11 hours of run time



125 LUMENS

Designed for sub-compact and compact weapons, this white light illuminator features a red laser to guide your aim. Operates in temperatures from -20°F to +120°F. IPX4-rated water-resistant.

TLR-4

BATTERY: (1) 3V "CR2" lithium

SIZE: 2.73" x 1.2" x 1.99"
(6.93 x 3.05 x 5.05 cm)

WEIGHT: 2.81 oz (79.7 g)

COLOR: Black

69240 Standard model includes rail locating keys for use with Picatinny or Glock® style rails. Lithium battery. Black.

69241 H&K USP Compact Model. Black.

69242 H&K USP Full-Size Model. Black.

TLR-4® G

WHITE LIGHT ILLUMINATOR // GREEN LASER

LUMENS: 115
CANDELA: 5,200
RUN TIME: 1h 15m

Laser only mode: 4 hours of run time



115 LUMENS

Extremely compact weapon-mounted light specifically designed for compact/sub-compact weapons, yet still fits a broad range of handguns. Produces a concentrated beam with optimum peripheral illumination. It includes a long-range green laser to help guide your aim. Thanks to new technology, the laser operates through an extended temperature range - from -20°F to +120°F. IPX4-rated water-resistant.

TLR-4 G

BATTERY: (1) 3V "CR2" lithium

SIZE: 2.73" x 1.2" x 1.99"
(6.93 x 3.05 x 5.05 cm)

WEIGHT: 2.81 oz (79.7 g)

COLOR: Black

69245 Standard model includes rail locating keys for use with Picatinny or Glock® style rails. Lithium battery. Black.

69246 H&K USP Compact Model. Black.

69247 H&K USP Full-Size Model. Black.

NON-RECHARGEABLE

TACTICAL WEAPON-MOUNTED SERIES
// STREAMLIGHT 2016

**DIFFERENT KINDS OF BEAMS
FOR DIFFERENT KINDS OF TASKS.**

WANT TO SEE THESE BEAMS IN ACTION?

Visit Streamlight's beamdemo.com and see the differences for yourself.

TRADITIONSERIES

This family of flashlights delivers the optimal balance of bright, far-reaching beam, ample peripheral light, and long run times. When you're out in the field or on any job that requires light for long periods, these are the flashlights you want by your side. Their brightness, power, performance, cost, and extended run times make them perfect for a variety of tasks.

HPLSERIES

These High Performance, High Lumen flashlights throw bright light a long distance. They have a bigger hot spot that casts more light on the target with more peripheral light all around you. They're great for illuminating the entire length of a dark alley, for inspecting utility lines from the ground, and for any task that requires a far-reaching beam.

HLSERIES

These High Lumen flashlights (500 - 2,000+ lumens) have a wide, side-to-side beam. They illuminate an entire area, including what may be hiding in corners. They perform like floodlights, illuminating a whole room, vehicle, or any area with bright, revealing light.



**TLR HL FAMILY OF
HIGH-LUMEN DOMINATION TH
MAXIMUM ILLUMIN**

TLR-1 HL® TLR-2 HL®

WHITE LIGHT ILLUMINATOR // HL SERIES

This versatile tactical light fits handguns and long-guns, and you can switch from one to the other in seconds. Its wide peripheral beam lets you see what's all around you, including what's lurking in corners. Includes a strobe for signaling/disorienting. Unbreakable, scratch-resistant, gasket-sealed lens. Operates in temperatures from -40°F to +120°F. TLR-1 HL IPX7-rated waterproof to 1 meter for 30 minutes. Impact resistant. Easy, fast battery installation/replacement. TLR-2 HL features a 640-660nm red laser and IPX4-rated for water resistance.

TLR-1 HL

BATTERY: (2) 3V "CR123A" lithium
SIZE: 3.39" x 1.47" x 1.44"
(8.61 x 3.73 x 3.65 cm)
WEIGHT: 4.18 oz (118.6 g)
COLOR: Black, Flat Dark Earth or Flat Dark Earth Brown

TLR-2 HL

BATTERY: (2) 3V "CR123A" lithium
SIZE: 3.39" x 1.47" x 1.83"
(8.61 x 3.73 x 4.64 cm)
WEIGHT: 4.78 oz (135.5 g)
COLOR: Black

| TLR-1 HL | TLR-2 HL | |
|----------|----------|--|
| 69260 | 69261 | Includes Rail Locating Keys for use with Glock® style, 1913 Picatinny, S&W 99/TSW, and Beretta® 90two. Lithium batteries. Black. |
| 69266 | - | Includes Rail Locating Keys for use with Glock® style, 1913 Picatinny, S&W 99/TSW, and Beretta® 90two. Lithium batteries. Flat Dark Earth. |
| 69267 | - | Includes Rail Locating Keys for use with Glock® style, 1913 Picatinny, S&W 99/TSW, and Beretta® 90two. Lithium batteries. Flat Dark Earth Brown. |
| 69262 | - | Long Gun Kit includes: TLR-1 HL with thumb screw and "safe off" door switch, remote pressure switch and mounting clips, lithium batteries. For pistol mounting the kit also includes standard door switch, rail locating keys. Lithium batteries. Black. |

WHITE LIGHT ILLUMINATOR // RED LASER



TLR-1 HL® Now Available in Flat Dark Earth and FDE Brown

UPDATED FOR 2016
800 LUMENS

HL® C4 LED With [(STROBE)]
Double tap tailswitch to activate.

LUMENS: 800
CANDELA: 15,000
DISTANCE: 245m
RUN TIME: 1h 15m

TLR-2HL Laser mode: 45 hours of run time



TLR-1 HL Long Gun Kit



TLR-2 HL® G

WHITE LIGHT ILLUMINATOR // GREEN LASER HL SERIES

We added a direct drive green laser to this powerful high-lumen weapon light. The green is clearly visible to guide your aim even in bright sunlight. You can count on the light and laser even in extreme temperatures from -40°F to +120°F. IPX4 rated for water resistance.

TLR-2 HL G

BATTERY: (2) 3V "CR123A" lithium
SIZE: 3.39" x 1.47" x 1.83"
(8.61 x 3.73 x 4.64 cm)
WEIGHT: 4.78 oz (135.5 g)
COLOR: Black

| | |
|-------|--|
| 69265 | Includes Rail Locating Keys for use with Glock® style, 1913 Picatinny, S&W 99/TSW, and Beretta® 90two. Lithium batteries. Black. |
|-------|--|

LUMENS: 800
CANDELA: 15,000
DISTANCE: 245m
RUN TIME: 1h 30m

Laser mode: 17 hours of run time

UPDATED FOR 2016
800 LUMENS

HL® C4 LED With [(STROBE)]
Double tap tailswitch to activate.



F LIGHTS
THROUGH
MATION.

NON-RECHARGEABLE

TACTICAL WEAPON-MOUNTED SERIES
// STREAMLIGHT 2016

TLR-1 HPL[®]

HIGH-LUMEN + LONG-DISTANCE.
SEE EVERYWHERE.

TLR-1 HPL[®]

This high lumen, long-range, rail-mounted tactical light has an intensely bright, far-reaching beam with a large hotspot. It throws a wide beam to illuminate your target downrange, while illuminating everything in your path. Fits long-guns. Attaches/detaches with one hand in seconds. Includes a strobe for signaling/disorienting. Operates in extreme temperatures (-40°F to +120°F). IPX7-rated. Impact-resistant. Easy, fast battery replacement.

TLR-1 HPL

BATTERY: (2) 3V "CR123A" lithium
SIZE: 4.83" x 1.44" x 2.2"
(12.27x 3.66 x 5.59 cm)
WEIGHT: 5.3 oz (150.3 g)
COLOR: Black

TLR-1 HPL W/REMOTE

BATTERY: (2) 3V "CR123A" lithium
SIZE: 5.25" x 1.44" x 2.2"
(13.34x 3.66 x 5.59 cm)
WEIGHT: 5.6 oz (158.8 g)
COLOR: Black

- 69215 Standard model. Includes Rail Locating Keys for use with Glock[®] style, 1913 Picatinny, S&W 99/TSW, and Beretta[®] 90two. Lithium batteries. Black.
- 69216 Remote model. Includes Rail Locating Keys for use with Glock[®] style, 1913 Picatinny, S&W 99/TSW, and Beretta[®] 90two. Remote switch and Lithium batteries. Black.
- 69219 Long Gun Kit with thumbscrew, "Safe Off" door switch and remote pressure switch. Includes Rail Locating Keys for use with Glock[®] style, 1913 Picatinny, S&W 99/TSW, and Beretta[®] 90two. Lithium batteries. Black.

WHITE LIGHT ILLUMINATOR // HPL SERIES

LUMENS: 775
CANDELA: 48,000
DISTANCE: 438m
RUN TIME: 1h 15m

775 LUMENS

*shown with
standard switch
backplate.*

*shown with
remote switch
backplate.*



With ((STROBE))
Double tap tailswitch to activate.

TLR-1® GAME SPOTTER®

GREEN LIGHT ILLUMINATOR // HPL SERIES

LUMENS: 150
CANDELA: 31,000
DISTANCE: 352m
RUN TIME: 1h 45m

150 LUMENS

*shown with
standard switch
backplate.*

*shown with
remote switch
backplate.*

 With **[(STROBE)]**
Double tap tailswitch to activate.

A long-gun/long-range light with a green LED that preserves night vision and won't spook game. Mounts directly to long-guns with MIL-STD-1913 (Picatinny) rails. Unbreakable, scratch-resistant, O-ring sealed lens. Operates in temperatures from -40°F to +120°F. IPX7-rated waterproof to 1 meter for 30 minutes. Impact resistant.

TLR-1 GAME SPOTTER

BATTERY: (2) 3V "CR123A" lithium

SIZE: 4.83" x 1.44" x 2.2"
(12.27 x 3.66 x 5.59 cm)

WEIGHT: 5.3 oz (150.3 g)

COLOR: Black

TLR-1 GAME SPOTTER W/REMOTE

BATTERY: (2) 3V "CR123A" lithium

SIZE: 5.25" x 1.44" x 2.2"
(13.34 x 3.66 x 5.59 cm)

WEIGHT: 5.6 oz (158.8 g)

COLOR: Black

69227 Standard model. Includes Rail Locating Keys for use with Glock® style, 1913 Picatinny, S&W 99/TSW, and Beretta® 90two. Lithium batteries. Black.

69228 Remote model. Includes Rail Locating Keys for use with Glock® style, 1913 Picatinny, S&W 99/TSW, and Beretta® 90two. Remote switch and Lithium batteries. Black.



NON-RECHARGEABLE

TACTICAL WEAPON-MOUNTED SERIES
// STREAMLIGHT 2016

THE TLR-2 G...
GREEN LASER
FOR ALL CONDITIONS.

TLR-2® G

Highly visible (even in daylight) green laser assists in target acquisition. Mounts directly to handguns with Glock®-style rails and to all MIL-STD-1913 (Picatinny) rails. Operates in temperatures from -40°F to 120°F. IPX4-rated for water-resistance. Features a strobe that can be disabled.

TLR-2 G

BATTERY: (2) 3V "CR123A" lithium

SIZE: 3.39" x 1.47" x 1.83"
(8.61 x 3.73 x 4.64 cm)

WEIGHT: 4.72 oz (133.8 g)

COLOR: Black

69250 Includes Rail Locating Keys for use with Glock® style, 1913 Picatinny, S&W 99/TSW, and Beretta® 90two. Lithium battery. Black.

WHITE LIGHT ILLUMINATOR // GREEN LASER TRADITION SERIES

LUMENS: 300
CANDELA: 12,000
DISTANCE: 159m
RUN TIME: 2h 30m

Laser mode: 17 hours of run time

300 LUMENS



With **[(STROBE)]**
Double tap tailswitch to activate.

Mounts directly to handguns with Glock®-style rails and to all MIL-STD-1913 (Picatinny) rails.



TLR-1® // TLR-1's

Intensely bright, durable tactical light available in standard or strobe. Securely fits a broad range of weapons. Produces a concentrated beam with optimum peripheral illumination. Mounts directly to handguns with Glock®-style rails and to all MIL-STD-1913 (Picatinny) rails. Operates in temperatures from -40°F to +120°F. IPX7-rated waterproof to 1 meter for 30 minutes. Impact resistant. The TLR-1s includes a strobe.

TLR-1 / TLR-1s

BATTERY: (2) 3V "CR123A" lithium

SIZE: 3.39" x 1.47" x 1.44"
(8.61 x 3.73 x 3.65 cm)

WEIGHT: 4.18 oz (118.6 g)

COLOR: Black

- | | |
|-------|---|
| 69110 | Includes Rail Locating Keys for use with Glock® style, 1913 Picatinny, S&W 99/TSW, and Beretta® 90two. Lithium batteries. Black. |
| 69210 | Strobe model includes Rail Locating Keys for use with Glock® style, 1913 Picatinny, S&W 99/TSW, and Beretta® 90two. Lithium batteries. Black. |
| 69211 | Strobe model with Earless Screw Kit, includes Rail Locating Keys for use with Glock® style, 1913 Picatinny, S&W 99/TSW, and Beretta® 90two. Lithium batteries. Black. |

WHITE LIGHT ILLUMINATOR // TRADITION SERIES

LUMENS: 300
CANDELA: 12,000
DISTANCE: 219m
RUN TIME: 2h 30m

300 LUMENS



LED With **[(STROBE)]**
Double tap tailswitch to activate.

AVAILABLE WITH STROBE

TLR-2® // TLR-2's

The same great features as the TLR-1 lights with a 650-600nm red laser for accurate aiming. Strobe ("s") model available.

TLR-2 / TLR-2s

BATTERY: (2) 3V "CR123A" lithium

SIZE: 3.39" x 1.47" x 1.83"
(8.61 x 3.73 x 4.64 cm)

WEIGHT: 4.72 oz (133.8 g)

COLOR: Black

- | | |
|-------|---|
| 69120 | with Red Laser. Includes Rail Locating Keys for use with Glock® style, 1913 Picatinny, S&W 99/TSW, and Beretta® 90two. Lithium batteries. Black. |
| 69230 | Strobe model w/ Red Laser. Includes Rail Locating Keys for use with Glock® style, 1913 Picatinny, S&W 99/TSW, and Beretta® 90two. Lithium batteries. Black. |

WHITE LIGHT ILLUMINATOR // RED LASER // TRADITION SERIES

LUMENS: 300
CANDELA: 12,000
DISTANCE: 219m
RUN TIME: 2h 30m

Laser mode: 48 hours of run time

300 LUMENS



LED With **[(STROBE)]**
Double tap tailswitch to activate.

AVAILABLE WITH STROBE

NON-RECHARGEABLE

TACTICAL WEAPON-MOUNTED SERIES
// STREAMLIGHT 2016

STREAMLIGHT

OFFERS A COMPLETE RANGE OF
IR ILLUMINATORS AND LASERS FOR
USE WITH NIGHT VISION GOGGLES.

TLR-2® IRW

TLR-2® IR EYE SAFE

TLR-1® IR LED

WHITE LIGHT ILLUMINATOR // EYE SAFE IR LASER

LUMENS: 300
CANDELA: 12,000
IR OUTPUT: Less than .8mW
DISTANCE: 219m
RUN TIME: 2h 30m
Laser mode: 45+ hours of run time



300 LUMENS



IR ILLUMINATOR // EYE SAFE IR LASER

IR OUTPUT: Less than .8mW
IR RUN TIME: 7h 30m
IR Laser mode: 45+ hours of run time



IR ILLUMINATOR

IR OUTPUT: 125mW/sr
IR RUN TIME: 7h 30m



Features a Class 1 "Eye Safe" Infrared laser along with a blinding bright white light for long-range targeting. User programmable strobe enable/disable. Mounts directly to handguns with Glock®-style rails and to all MIL-STD-1913 (Picatinny) rails. Operates in temperatures from -40°F to +140°F. IPX4-rated for water-resistance.

TLR-2 IRW EYE SAFE

BATTERY: (2) 3V "CR123A" lithium
SIZE: 3.39" x 1.47" x 1.83"
(8.61 x 3.73 x 4.64 cm)
WEIGHT: 4.72 oz (133.8 g)
COLOR: Black

69165 TLR-2 IRW. Includes Rail Locating Keys for use with Glock® style, 1913 Picatinny, S&W 99/TSW, and Beretta® 90two. Lithium batteries. Black.

Lightweight, compact, lithium battery powered Gun-Mounted Infrared Active Illuminator with Class 1 eye safe integrated IR aiming laser. The Illuminator features the latest in shock-proof high power infrared LED technology providing at least 7.5 hrs of continuous run time when in dual mode with the infrared laser. Rail clamp designed to rapidly attach/detach from side of weapon.

TLR-2 IR EYE SAFE

BATTERY: (2) 3V "CR123A" lithium
SIZE: 3.39" x 1.47" x 1.83"
(8.61 x 3.73 x 4.64 cm)
WEIGHT: 4.72 oz (133.8 g)
COLOR: Black

69166 IR w/ Eye Safe Laser. Includes Rail Locating Keys for use with Glock® style, 1913 Picatinny, S&W 99/TSW, and Beretta® 90two. Lithium batteries. Black.

Lightweight, compact, lithium battery powered Gun-Mounted Active Illuminator featuring the latest in high power infrared LED technology. The illuminator is built with a shock-proof LED and provides at least 7.5 hours of continuous run time. Rail clamp designed to rapidly attach/detach from side of weapon.

TLR-1 IR LED

BATTERY: (2) 3V "CR123A" lithium
SIZE: 3.26" x 1.47" x 1.44"
(8.28 x 3.73 x 3.65cm)
WEIGHT: 4.18 oz (118.6 g) with batteries
COLOR: Black

69150 IR. Includes Rail Locating Keys for use with Glock® style, 1913 Picatinny, S&W 99/TSW, and Beretta® 90two. Lithium batteries. Black.



TLR-VIR® PISTOL

WHITE LIGHT ILLUMINATOR // IR ILLUMINATOR



Ambidextrous momentary steady-on-off switch



300 LUMENS



| | |
|-------------------|-----------|
| TLR-VIR PISTOL | |
| LUMENS: | 300 |
| CANDELA: | 11,000 |
| IR OUTPUT: | 1000mW/sr |
| VISIBLE RUN TIME: | 2h 30m |
| IR RUN TIME: | 32h |

This combination bright white C4® LED and infrared illuminator is designed for use with a pistol. It has a lower profile than the original TLR-VIR, and it's waterproof to 66 ft. in its standard configuration. The IR illuminator is within the same lens as the white light. You can easily transition from white light to IR with a switch at the bottom of the light. There's no need to remove your eyes from the target or alter your firing grip. It has the standard momentary and constant-on ambidextrous switch as well.

TLR-VIR PISTOL

BATTERY: (2) 3V "CR123A" lithium

SIZE: 3.39" x 1.47" x 1.44"
(8.61 x 3.73 x 3.65cm)

WEIGHT: 4.2 oz (119 g) with batteries

COLOR: Black

69190 Includes rail locating keys for used with Glock® style, 1913 Picatinny, S&W 99/TSW, and Beretta® 90two. Lithium batteries. Black.

TLR-VIR®

WHITE LIGHT ILLUMINATOR // IR ILLUMINATOR

| | |
|-------------------|-----------|
| TLR-VIR | |
| LUMENS: | 300 |
| CANDELA: | 12,000 |
| IR OUTPUT: | 1000mW/sr |
| VISIBLE RUN TIME: | 2h 30m |
| IR RUN TIME: | 20h |



300 LUMENS



opaque lens cover

Designed to be used with a long gun, includes both a white LED and an Infrared (IR) illuminator for use with night vision goggles. Also features programmable strobe. Momentary/steady On-Off switch with plug port for momentary remote switch. Switch between white and IR as needed. User programmable strobe enable/disable. Includes a standard mount and remote switch. Operates in temperatures from -40°F to +150°F. IPX7-rated waterproof to 1 meter for 30 minutes. Designed to fits all long guns with MIL-STD-1913 rails.

TLR-VIR

BATTERY: (2) 3V "CR123A" lithium







SIZE: 3.82" x 1.47" x 2.03"
(9.70 x 3.73 x 5.16cm)

WEIGHT: 6.0 oz (170 g) with batteries, retained lens cap and remote switch

COLOR: Black

69180 Includes opaque lens cover, remote switch, 1913 key. Lithium batteries. Black.

TLR SERIES ACCESSORIES

| TLR Accessories | TLR-1 HL/ TLR-2 HL | TLR-2 HL G | TLR-2 G | TLR-1/ TLR-1s | TLR-2/ TLR-2s | TLR-2 IR EYE SAFE | TLR-2 IRW | TLR-1 IR LED | TLR-1 HPL | TLR-1 GAMESPOTTER |
|---|--|---------------|---------|------------------|------------------|----------------------|--------------|-----------------|--------------|----------------------|
| Remington 870 Mount  | 69906 | 69906 | 69906 | 69906 | 69906 | 69906 | 69906 | 69906 | 69906 | 69906 |
| TLR 12 ga. Mag Mount  | 69901 | 69901 | 69901 | 69901 | 69901 | 69901 | 69901 | 69901 | 69901 | 69901 |
| AR-15 M16 Mount  | 69902 | 69902 | 69902 | 69901 | 69902 | 69902 | 69902 | 69901 | 69902 | 69902 |
| Ambidextrous Vert. Grip w/Rail  | 69114 | 69114 | 69114 | 69114 | 69114 | 69114 | 69114 | 69114 | 69114 | 69114 |
| TLR Key Kit  | 69175 | 69175 | 69175 | 69175 | 69175 | 69175 | 69175 | 69175 | 69175 | 69175 |
| Nylon Holster  | 1: 69201 2: 69202 | 69202 | 69202 | 69201 | 69202 | 69202 | 69202 | 69201 | - | - |
| Contour Remote -Glock®*  | 69300 | 69300 | 69300 | 69300 | 69300 | 69300 | 69300 | 69300 | - | - |
| Contour Remote -M6P*  | 69310 | 69310 | 69310 | 69310 | 69310 | 69310 | 69310 | 69310 | - | - |
| Door Switch  | 69130 | 69130 | 69130 | 69130 | 69130 | 69130 | 69130 | 69130 | 69130 | 69130 |
| Door Switch w/Safe Off  | 69161 | 69161 | 69161 | 69161 | 69161 | 69161 | 69161 | 69161 | 69161 | 69161 |
| Tape Switch  | 69132 | 69132 | 69132 | 69132 | 69132 | 69132 | 69132 | 69132 | 69132 | 69132 |
| Coil Pressure Switch  | 69134 | 69134 | 69134 | 69134 | 69134 | 69134 | 69134 | 69134 | 69134 | 69134 |
| Straight Press. Switch  | 69135 | 69135 | 69135 | 69135 | 69135 | 69135 | 69135 | 69135 | 69135 | 69135 |
| Red Flip Lens  | 69115 | 69115 | 69115 | 69115 | 69115 | - | 69115 | - | - | - |
| Blue Flip Lens  | 69116 | 69116 | 69116 | 69116 | 69116 | - | 69116 | - | - | - |
| Green Flip Lens | 69117 | 69117 | 69117 | 69117 | 69117 | - | 69117 | - | - | - |
| IR Flip Lens | 69118 | 69118 | 69118 | 69118 | 69118 | - | 69118 | - | - | - |
| Opaque Flip Lens | 69124 | 69124 | 69124 | 69124 | 69124 | 69124 | 69124 | 69124 | - | - |
| CR123 Batteries | 2 Pk. // 85175 6 Pk. // 85180 12 Pk. // 85177 400 Pk. // 85179 | | | | | | | | | |

* Note: Must be used in conjunction with 69130 remote door switch. Fits Glock® 17/22 and 19/23 size frames; or Smith & Wesson M6P frames.



IT'S A DUTY LIGHT, BUILT WITH PRECISION AND PERFORMANCE.

STINGER DS LED HL®
STINGER LED HL®

Everything you love about the Stinger with more lumens for more brightness and a wider beam that lights up a whole area from side to side. Now you'll see the dangers that may be hiding in corners in rooms, tunnels, alleyways, cars, and more.

STINGER DS LED HL

BATTERY: 3-cell, 3.6V NiMH sub-C

DS SIZE: 8.85" x 1.62" x 1.17"
(22.48 x 4.11 x 2.97 cm)

DS WEIGHT: 12.8 oz (364 g)

COLOR: Black

STINGER LED HL

BATTERY: 3-cell, 3.6V NiMH sub-C

SIZE: 8.41" x 1.62" x 1.17"
(21.36 x 4.11 x 2.97 cm)

WEIGHT: 12.4 oz (352 g)

COLOR: Black or Kryptek®

DS LED HL LED HL

| | | |
|-------|-------|--|
| 75454 | 75430 | with 120V AC/12V DC - 2 holders (NiMH)-Black |
| 75455 | 75431 | with 120V AC (NiMH)-Black |
| 75456 | 75432 | with 12V DC (NiMH)-Black |
| 75458 | 75434 | with 120V AC/12V DC - 1 PiggyBack (NiMH)-Black |
| - | 75699 | with 120V AC/12V DC - 1 PiggyBack (NiMH)-Kryptek |
| 75457 | 75433 | with 120V AC/12V DC - Fast Charge 2 holders (NiMH)-Black |
| 75453 | 75429 | without Charger (NiMH)-Black |
| - | 75698 | without Charger (NiMH)-Kryptek |

| | HIGH | MEDIUM | LOW |
|------------------|--------|--------|-------|
| LUMENS: | 640 | 340 | 170 |
| CANDELA: | 22,000 | 11,000 | 5,500 |
| DISTANCE: | 297m | 210m | 148m |
| RUN TIME: | 1.25h | 2h | 4h |

Strobe mode: 3 hours of continuous run time



640 LUMENS

HL®
Dual Switch
TECHNOLOGY
C4 LED With **[(STROBE)]**
Double tap switch to activate.
AVAILABLE IN BOTH DUAL SWITCH AND STANDARD STYLES

STINGER DS HPL®
STINGER HPL®

The Stinger® HPL™ has combined two intensely bright illumination patterns into one multi-tasking beam giving you clarity up-close and deep into the horizon. Its long distance beam reaches 438 meters and the 740 lumen beam provides side to side visibility to fill in up-close areas and corners. NiMH battery.

STINGER DS HPL

BATTERY: 3-cell, 3.6V NiMH sub-C

DS SIZE: 9.65" x 2.20" x 1.17"
(24.51 x 5.59 x 2.97 cm)

DS WEIGHT: 14.0 oz (396 g)

COLOR: Black

STINGER HPL

BATTERY: 3-cell, 3.6V NiMH sub-C

SIZE: 9.23" x 2.20" x 1.17"
(23.44 x 5.59 x 2.97 cm)

WEIGHT: 13.6 oz (385 g)

COLOR: Black

DS LED HPL LED HPL

| | | |
|-------|-------|--|
| 75763 | 75863 | with 120V AC/12V DC - 2 holders (NiMH) |
| 75761 | 75861 | with 120V AC (NiMH) |
| 75799 | 75899 | with 12V DC (NiMH) |
| 75782 | 75882 | with 120V AC/12V DC - 1 PiggyBack (NiMH) |
| - | 75885 | with 120V AC/12V DC - Fast Charge (NiMH) |
| 75900 | 75980 | without Charger (NiMH) |

| | HIGH | MEDIUM | LOW |
|------------------|--------|--------|--------|
| LUMENS: | 740 | 380 | 190 |
| CANDELA: | 48,000 | 24,000 | 12,000 |
| DISTANCE: | 438m | 310m | 219m |
| RUN TIME: | 1h 15m | 2h 30m | 4h 30m |

Strobe mode: 3 hours of continuous run time



740 LUMENS

Dual Switch
TECHNOLOGY
C4 LED With **[(STROBE)]**
Double tap switch to activate.
AVAILABLE IN BOTH DUAL SWITCH AND STANDARD STYLES

STINGER SERIES
// STREAMLIGHT 2016

STINGER DS[®] LED
STINGER[®] LED

TRADITION SERIES

| | HIGH | MEDIUM | LOW |
|------------------|--------|--------|-------|
| LUMENS: | 350 | 175 | 85 |
| CANDELA: | 24,000 | 12,000 | 6,000 |
| DISTANCE: | 310m | 219m | 155m |
| RUN TIME: | 2h | 3.75h | 7.25h |

Strobe mode: 5.5 hours of continuous run time



350 LUMENS



With **[(STROBE)]**
Double tap switch to activate.

AVAILABLE IN BOTH DUAL SWITCH AND STANDARD STYLES

The Stinger LED and Stinger DS LED deliver the optimal balance of performance and value with the longest run time in the Stinger family. The DS model provides both a tailcap and head switch.

STINGER DS LED

BATTERY: NiMH or NiCd
DS SIZE: 8.85" x 1.62" x 1.17"
(22.48 x 4.11 x 2.97 cm)
DS WEIGHT: 12.8 oz (364 g)
COLOR: Black

STINGER LED

BATTERY: NiMH or NiCd
SIZE: 8.41" x 1.62" x 1.17"
(21.36 x 4.11 x 2.97 cm)
WEIGHT: 12.4 oz (352 g)
COLOR: Black or Kryptek[®]

| DS LED | LED | (NiCd Battery unless otherwise noted) |
|--------|-------|--|
| 75813 | 75713 | with 120V AC/12V DC Steady Charge-Black |
| 75811 | 75711 | with 120V AC Steady Charge-Black |
| 75832 | 75732 | with 120V AC/12V DC Steady PiggyBack [®] -Black |
| - | 75693 | with 120V AC/12V DC Steady PiggyBack [®] -Kryptek |
| 75835 | 75735 | with 120V AC/12V DC Fast Charge-Black |
| 75812 | 75712 | with 12V DC Steady Charge-Black |
| 75853 | 75753 | with 12V DC Steady Charge (NiMH)-Black |
| 75810 | 75710 | without Charger-Black |
| - | 75692 | without Charger-Kryptek |
| 75970 | 75960 | without Charger (NiMH)-Black |

ULTRASTINGER[®] LED

HL SERIES

| | HIGH | MEDIUM | LOW |
|------------------|--------|--------|-------|
| LUMENS: | 1,100 | 350 | 90 |
| CANDELA: | 65,000 | 21,000 | 5,000 |
| DISTANCE: | 510m | 290m | 141m |
| RUN TIME: | 1h 30m | 4h 30m | 16h |

Strobe mode: 3h 15m of continuous run time



TEN-TAP[®] programmable switch allows user selection of one of three different programs:

- High/medium/low with strobe (factory default)
- High only without strobe
- High/medium/low without strobe

1,100 LUMENS



With **[(STROBE)]**
Double tap switch to activate.

We pumped up the brightness to give the UltraStinger LED a piercing 1,100 lumens. But that's not all. It now has a farther-reaching beam, TEN-TAP[®] programming for its multiple intensities and strobe; plus we added a rubber sleeve for a better grip. It's IPX4 rated for water resistance and it works with existing Stinger[®] chargers and accessories.

ULTRASTINGER LED

BATTERY: 5-cell, 6V Ni-MH sub-C
SIZE: 11.82" x 2.37" x 1.19"
(30 x 6.01 x 3 cm)
WEIGHT: 19.9 oz (564 g)
COLOR: Black

| | |
|-------|--------------------------------|
| 77553 | with AC/DC Steady Charge-Black |
| 77554 | with AC/DC Fast Charge-Black |
| 77551 | with AC Steady Charge-Black |
| 77552 | with AC Fast Charge-Black |
| 77555 | with DC Steady Charge-Black |
| 77556 | with DC Fast Charge-Black |
| 77550 | without Charger-Black |

STINGER ACCESSORIES

| Stinger Accessories | DS LED HL LED HL | DS LED HPL LED HPL | DS LED LED | UltraStinger LED |
|---|------------------|--------------------|------------|------------------|
| 5 Unit Bank Charger | 75400 | 75400 | 75400 | 75400 |
| 2.5 hr Fast Charger | 75103 | 75103 | 75103 | 75103 |
| Fast Piggyback[®] Charger | 75276 | 75276 | 75276 | - |
| Steady Piggyback[®] | 75275 | 75275 | 75275 | - |
| NiCd Battery Stick | - | 75175 | 75175 | - |
| NiMH Battery Stick | 75375 | 75375 | 75375 | 77375 |
| 12V Cig Charge Cord | 22051 | 22051 | 22051 | 22051 |
| 12V DC Charge Cord | 22050 | 22050 | 22050 | 22050 |
| 120V AC Charge Cord | 22311 | 22311 | 22311 | 22311 |
| Leather Plain Holster | 75133 | - | 75133 | - |
| Leather Weave Holster | 75134 | - | 75134 | - |
| Std. Nylon Holster | 75927 | 75927 | 75927 | - |
| Loop Nylon Holster | 75928 | 75928 | 75928 | 75928 |
| Duty Holster | 88053 | 88053 | 88053 | 88053 |
| Ring Holder | 75906 | 75906 | 75906 | 75906 |
| Red Flip Lens | 75115 | - | 75115 | - |
| Green Flip Lens | 75117 | - | 75117 | - |
| Blue Flip Lens | 75116 | - | 75116 | - |
| Red Wand | 75903 | 75946 | 75903 | 78903 |
| White Wand | 75908 | 75949 | 75908 | 78908 |
| Blue Wand | 75902 | 75947 | 75902 | 78902 |
| Yellow Wand | 75904 | 75948 | 75904 | 78904 |
| Glow Wand | 75913 | 75950 | 75913 | 78913 |

NON-RECHARGEABLE

PROPOLYMER[®] SERIES

// STREAMLIGHT 2016



STINGER DUTY HOLSTER

- Super-tough nylon construction
- Quick, Easy Access

STINGER DUTY HOLSTER - 88053

3AA PROPOLYMER[®] DUALIE[®]

| | SPOT | FLOOD |
|-----------|-------|-------|
| LUMENS: | 140 | 140 |
| CANDELA: | 7,300 | 80 |
| DISTANCE: | 171m | 18m |
| RUN TIME: | 18h | 18h |

// NEW FOR 2016



Features a forward facing LED spot beam and a side facing LED flood light that can be used individually or at the same time for enhanced safety.



Class I & II, Div. I, Groups A,B,C,D,F,G
Class III, CL I, ZN O, IIC
T-Code: T4; Exia



3AA PROPOLYMER[®] DUALIE[®] LASER

| | LED | LASER |
|-----------|-------|-------------|
| LUMENS: | 150 | <5mW output |
| CANDELA: | 7,700 | - |
| DISTANCE: | 175m | - |
| RUN TIME: | 17h | 70h |

// NEW FOR 2016

Simultaneous spot beam and laser pointer allow you to illuminate the work area and pinpoint out-of-reach objects.



Class I & II, Div. I, Groups A,B,C,D,F,G
Class III, CL I, ZN O, IIC
T-Code: T4; Exia



Rugged, integrated, snag-free clip conforms to body of light; grabs onto shirts, pockets and gear for hands-free use.

One light, two beams: Choose one spot beam or one flood light or both. The Dualie[®] provides two types of illumination for multi-directional lighting and special uses. Intuitive activation allows you to use either beam or both at the same time. This intrinsically safe flashlight allows you to see your entire work area and helps you avoid slips, trips, and falls.

3AA PROPOLYMER DUALIE

BATTERY: 3 "AA" size alkaline or lithium batteries

SIZE: 7.00" x 1.86" x 1.06"
(17.78 x 3.86 x 2.69 cm)

WEIGHT: 6.8 oz (193 g)

COLOR: Yellow or Black

| | |
|-------|---------------------------------------|
| 68750 | White LED/alkaline batteries - Yellow |
| 68752 | White LED/alkaline batteries - Black |

ACCESSORIES

| | |
|-------|---------------------|
| 68089 | Poly Mount Kit |
| 99075 | Rubber Helmet Strap |

The 3AA Propolymer[®] Dualie[®] Laser is an intrinsically safe, high performance, 3 AA battery powered dual function LED flashlight. The Dualie Laser model features forward facing LED spot beam and laser pointer that can be used individually or at the same time for location identification. Opposing switches for easy user activation of desired function(s).

3AA PROPOLYMER DUALIE LASER

BATTERY: 3 "AA" size alkaline or lithium batteries

SIZE: 7.00" x 1.86" x 1.06"
(17.78 x 3.86 x 2.69 cm)

WEIGHT: 6.8 oz (193 g)

COLOR: Yellow or Black

| | |
|-------|---|
| 68760 | White LED/Laser/alkaline batteries - Yellow |
| 68762 | White LED/Laser/alkaline batteries - Black |

ACCESSORIES

| | |
|-------|---------------------|
| 68089 | Poly Mount Kit |
| 99075 | Rubber Helmet Strap |

RECHARGEABLE COMPACT

STRION SERIES
// STREAMLIGHT 2016

LITTLE
IN STATURE, BIG IN LIGHT.

STRION LED HL®

The power of a Stinger in a more compact Lithium Ion rechargeable flashlight. It even fits long-gun mounts. Casts a bright white beam that spreads out to illuminate an entire area. You'll see what's in front of you and what may be hiding in the corners.

STRION LED HL

BATTERY: Lithium-ion with on-board safety control circuit. 3.75V, 2000m Ah minimum.

SIZE: 5.90" x 1.25" x .95" (14.99 x 3.18 x 2.41 cm)

WEIGHT: 5.2 oz (148 g)

COLOR: Black or Kryptek®

BLACK KRYPTEK

| | | |
|-------|-------|--|
| 74752 | - | with 120V AC/12V DC - 2 holders |
| 74751 | - | with 120V AC/12V DC - 1 holder |
| 74755 | - | with 120V AC/12V DC - 1 holder |
| 74778 | 74395 | with 120V AC/12V DC - 1 PiggyBack |
| 74753 | - | with 120V AC |
| 74754 | - | with 12V DC |
| 74750 | 74394 | without Charger |
| 74509 | - | Strion LED HL with grip - with 120V AC |

HL SERIES

| | HIGH | MEDIUM | LOW |
|------------------|--------|--------|--------|
| LUMENS: | 500 | 250 | 125 |
| CANDELA: | 10,000 | 5,000 | 2,500 |
| DISTANCE: | 200m | 141m | 100m |
| RUN TIME: | 1h | 2h | 3h 30m |

Strobe mode: 2.5 hours of continuous run time



- Special Features:**
- IPX4-rated for water-resistance.
 - 2 meter impact-resistance tested.

500 LUMENS **HL** **LED** With **[(STROBE)]**
Double tap switch to activate.

STRION ACCESSORIES

| Strion Accessories | STRION LED HL | STRION LED HPL | STRION LED |
|--------------------------|---------------|----------------|------------|
| 6 Unit Bank Charger 120V | 74400 | 74400 | 74400 |
| 6 Unit Bank Charger DC | 74401 | 74401 | 74401 |
| Piggyback Charger Holder | 74115 | 74115 | 74115 |
| Charger Holder | 74102 | 74102 | 74102 |
| Li-ion Battery Stick | 74175 | 74175 | 74175 |
| 12V Cig Charge Cord | 22051 | 22051 | 22051 |
| 12V DC Charge Cord | 22050 | 22050 | 22050 |
| 120V AC Charge Cord | 22311 | 22311 | 22311 |
| Rail Mount | 74200 | 74200 | 74200 |
| Vertical Grip | 69114 | 69114 | 69114 |
| Leather Plain Holster | 74059 | - | 74059 |
| Leather Weave Holster | 74060 | - | 74060 |
| Std. Nylon Holster | - | 75910 | - |
| Nylon Option Holster | 85905 | - | 85905 |
| Tactical Holster | 88051 | 88051 | 88051 |
| Red Flip Lens | 85115 | - | 85115 |
| Green Flip Lens | 85117 | - | 85117 |
| Blue Flip Lens | 85116 | - | 85116 |
| Red Wand | 74903 | 75946 | 74903 |
| White Wand | - | 75949 | - |
| Blue Wand | 74902 | 75947 | 74902 |
| Yellow Wand | - | 75948 | - |
| Glow Wand | 74913 | 75950 | 74913 |

STRION® HPL

STRION® LED

NEW STRION® PIGGYBACK CHARGER



STRION PIGGYBACK CHARGER – 74115

- Always Be Ready
- Charge via 12v DC, 120 AC or USB
- Quick, and Convenient
- Charges Light & Spare Battery

| | HIGH | MEDIUM | LOW |
|------------------|--------|--------|--------|
| LUMENS: | 615 | 320 | 160 |
| CANDELA: | 40,000 | 20,000 | 10,000 |
| DISTANCE: | 400m | 283m | 200m |
| RUN TIME: | 1h | 2h | 3h 45m |

Strobe mode: 2.5 hours of continuous run time



615 LUMENS



Special Features:

- Scratch-resistant, unbreakable, O-ring sealed lens.
- IPX4-rated for water-resistance.
- 2 meter impact-resistance tested.

HPL SERIES

Lightweight and ultra-compact, yet extremely powerful. It throws its long beam far out in the distance while casting plenty of peripheral light along the way. Features three intensities plus strobe. Rechargeable battery and powerful illumination result in one of the lowest operating costs of any flashlight. Easy, one-handed operation with multi-function push-button tailswitch.

STRION HPL

BATTERY: Lithium-ion with on-board safety control circuit. 3.75V, 2000m Ah minimum.

SIZE: 7.00" x 2.2" x .95"
(17.78 x 5.59 x 2.41 cm)

WEIGHT: 7.1 oz (202 g)

COLOR: Black

| | |
|-------|---|
| 74501 | with 120V AC/12V DC – 1 Holder – Black |
| 74502 | with 120V AC/12V DC – 2 Holders – Black |
| 74536 | with 120V AC/12V DC – 1 PiggyBack |
| 74503 | with 120V AC – Black |
| 74504 | with 12V DC – Black |
| 74500 | without Charger – Black |

| | HIGH | MEDIUM | LOW |
|------------------|--------|--------|--------|
| LUMENS: | 260 | 130 | 65 |
| CANDELA: | 10,000 | 5,000 | 2,500 |
| DISTANCE: | 200m | 141m | 100m |
| RUN TIME: | 2h | 4h | 7h 30m |

Strobe mode: 5.5 hours of continuous run time



260 LUMENS



Special Features:

- 2 meter impact-resistance tested.
- Anti-roll ring included.

TRADITION SERIES

A powerful value that's perfect for the broadest range of lighting needs. IPX4-rated for water-resistance. Anti-roll ring included. Optional model with adjustable Grip Ring provides a sure-grip for easy one-handed operation.

STRION LED

BATTERY: Lithium-ion with on-board safety control circuit. 3.75V, 2000m Ah minimum.

SIZE: 5.9" x 1.25" x .95" (14.99 x 3.18 x 2.41 cm)

WEIGHT: 5.2 oz (148 g)

COLOR: Black, Pink or Kryptek®

| | |
|-------|--|
| 74301 | with 120V AC/12V DC – 1 Holder – Black |
| 74302 | with 120V AC/12V DC – 2 Holders – Black |
| 74303 | with 120V AC – Black |
| 74304 | with 12V DC – Black |
| 74308 | with 120V AC/12V DC – Black – Clam |
| 74353 | with 120V AC/12V DC – 1 PiggyBack – Black |
| 74369 | with 120V AC/12V DC – 1 PiggyBack – Kryptek® |
| 74361 | with 120V AC/12V DC – 1 PiggyBack – Pink |
| 74300 | without Charger – Black |
| 74368 | without Charger – Kryptek® |
| 74309 | with Grip Ring 120V AC – Black |
| 74350 | with 120V AC/12V DC – 1 Holder – Pink |

NON-RECHARGEABLE

HAND-HELD & USB FLASHLIGHT SERIES

// STREAMLIGHT 2016

SCORPION® HL

HL SERIES

| | HIGH | LOW |
|-----------|----------|-----|
| LUMENS: | 725 | 35 |
| CANDELA: | 18,500 | 950 |
| DISTANCE: | 272m | 62m |
| RUN TIME: | 1h 15min | 18h |

Strobe runs 2.5 hours

TEN-TAP® programmable switch allows user selection of one of three different programs:

- high/strobe/low (factory default)
- high only
- low/high



HL With **C4 LED** [(STROBE)] **725 LUMENS**
Double tap switch to activate.

The only tactical light with a rubberized grip and tail switch is now a water-resistant, high lumen flashlight! It has 725 lumens of blinding light, TEN-TAP® programming and a new sleeve design for better grip.

SCORPION HL

BATTERY: (2) 3V "CR123A" lithium

SIZE: 5.46" x 1.375" x .96"
(13.87 x 3.49 x 2.44 cm)

WEIGHT: 4.8 oz (136 g)

COLOR: Black

85400 with lithium batteries. Black.

STYLUS PRO® 360

| | |
|-----------|--------|
| LUMENS: | 65 |
| CANDELA: | 430 |
| DISTANCE: | 41m |
| RUN TIME: | 6h 30m |

NEW FOR 2016



The 360 feature allows the light to be used as a small lantern

Rubber tail boot allows the light to stand upright

Versatile new light that functions as a typical Stylus Pro or adjust the head to reveal the 360 feature allows the light to be used as a small lantern. Equipped with a rubber tail boot allows the light to stand upright. It features a tail cap switch, momentary or constant on operation, a pocket clip for convenience, and amazing brightness and run time for a light of its size and price.

STYLUS PRO 360

BATTERY: (2) "AAA" alkaline

SIZE: 5.9" x .64"
(150 x 16.25 cm)

WEIGHT: 1.9 oz (53.8 g)

COLOR: Black

66218 Stylus Pro 360-Black

STYLUS PRO® USB & USB UV

| | |
|----------------|--------|
| UV LED OUTPUT: | 325mW |
| UV RUN TIME: | 2h 30m |

NEW FOR 2016



Sliding metal sleeve protects micro USB port

| | |
|-----------|------|
| LUMENS: | 70 |
| CANDELA: | 630 |
| DISTANCE: | 50m |
| RUN TIME: | 3.5h |

Recharge by plugging into USB port or optional AC wall adapter

You won't want to be without this sleek, compact penlight that recharges at any USB port or with optional AC wall adaptor. Now we have a UV model! Consistent light output throughout battery life. IPX4 water-resistant. 1 meter impact-resistance tested.

STYLUS PRO USB & STYLUS PRO USB UV

BATTERY: Lithium ion

SIZE: 6.15" x .74" (15.6 x 1.9 cm)

WEIGHT: 1.9 oz (53.8 g)

COLOR: Black

| | |
|-------|--|
| 66149 | Stylus Pro USB UV, USB Cord, Nylon Holster |
| 66148 | UV with 120V AC adapter, USB Cord, Nylon holster-Black |
| 22057 | USB Cord |
| 22058 | 120V AC Wall Adapter |
| 66029 | Holster |

EPU-5200™ POWER UNIT

Take the power with you! Charge your light wherever you need to. (Light not included).



Charges most USB products with micro-USB input.

- 4+ full charges for Streamlight Stylus ProUSB, Clipmate USB and Double Clutch USB
- 2 full charges for Streamlight ProTac HL USB
- 1+ full charges for most smartphones and tablets

We've made it easier than ever to keep your USB flashlights and mobile devices powered up and ready. You can clip the electronic power unit to a vest and take it anywhere. It's lightweight, yet rugged and durable to stand up to almost anything. And it's also a flashlight! IPX4 water-resistant with cover installed.

EPU-5200

BATTERY: Lithium ion cell pack
SIZE: 4.45" x 1.83" x 1.25" (11.3 x 4.7 x 3.2 cm)
WEIGHT: 5.4 oz (153 g)
COLOR: Black

22600 with USB cord—Black

CLIPMATE® USB



Flexible, extension cable targets the beam where you need it



| WHITE LED | HIGH | LOW |
|-----------|--------|-----|
| LUMENS: | 70 | 10 |
| CANDELA: | 500 | 50 |
| DISTANCE: | 44m | 14m |
| RUN TIME: | 3h 30m | 24h |

Dual LEDs:
 High-intensity white LED
 Night vision red LED

| RED LED | HIGH | LOW |
|-----------|------|-----|
| LUMENS: | .5 | .2 |
| CANDELA: | 9 | 3 |
| DISTANCE: | 6m | 3m |
| RUN TIME: | 16h | 65h |

This multi-function light clips to pocket or cap for hands-free use. Recharges by plugging into USB port or optional AC wall adaptor. IPX4 water-resistant. 1 meter impact-resistance tested.

CLIPMATE USB

BATTERY: Lithium polymer cell
SIZE: 3.20" x 1.39" x .65"
 (8.1 x 3.5 x 1.7 cm)
WEIGHT: 1.9 oz (53.8 g)
COLOR: Black



61125 Light only—Black
 61126 120V AC—Black

DOUBLE CLUTCH™ USB HEADLAMP



| LITHIUM POLYMER | HIGH | LOW | ALKALINE "AAA" | HIGH | LOW |
|-----------------|--------|-----|----------------|-------|-----|
| LUMENS: | 125 | 30 | LUMENS: | 125 | 30 |
| SPOT DIST: | 82m | 40m | SPOT DIST: | 82m | 40m |
| SPOT CANDELA: | 1,700 | 400 | SPOT CANDELA: | 1,700 | 400 |
| FLOOD DIST: | 31m | 4m | FLOOD DIST: | 31m | 4m |
| FLOOD CANDELA: | 250 | 70 | FLOOD CANDELA: | 250 | 70 |
| RUN TIME: | 3h 30m | 10h | RUN TIME: | 6h | 18h |

This dual-power, dual-function, dual-output headlamp gives you the flexibility of using either a USB-rechargeable battery or 3 AAA alkaline batteries. It also lets you choose either a spot or a flood beam, both with high and low mode. It's lightweight and long-running with a 60° tilting head. Unbreakable lens. IPX4-rated. Water-resistant. 2 meter impact resistance tested.

DOUBLE CLUTCH USB

BATTERY: Rechargeable Lithium Polymer pack or (3) "AAA"
SIZE: 1.75" x 2.50" x 1.66"
 (4.44 x 6.35 x 4.22 cm)
WEIGHT: 4.0 oz (113 g)
COLOR: Yellow or Black

YELLOW BLACK

61602 61603 with 120V AC—elastic and rubber straps
 61600 61601 with USB Cord Only
 61607 61608 Alkaline Model

NON-RECHARGEABLE

MILITARY HANDS-FREE / SIGNALING SERIES
// STREAMLIGHT 2016

SIDEWINDER...

THE MOST VERSATILE

SIDEWINDER®

Meets a wide variety of hands-free illumination requirements with various color LEDs at different outputs. 185° tilting head and belt/web clip for multiple positioning/aiming of light. Designed for easy selection of light modes when in the field and when wearing gloves. IPX7-rated waterproof to 1 meter for 30 minutes. 3 meter impact-resistance tested. O-ring and gasket-sealed for waterproof operation. Meets MIL-STD-810F, METHOD 512.4.

SIDEWINDER

BATTERY: (2) "AA" alkaline or (2) "AA" lithium for extended operation in extreme temperatures (-40° F to +150°F)

SIZE: 2.34" x 1.08" x 4.65"
(5.94 x 2.74 x 11.81 cm)

LITHIUM WEIGHT: 4.38 oz (124 g)

ALKALINE WEIGHT: 5.02 oz (142 g)

COLOR: Coyote

LUMENS: 55

CANDELA: 1,175

DISTANCE: 69m

RUN TIME: 5h 30m

Military Model

14000 w/alkaline-White C4 LED, Red, Blue, IR LEDs. Clam packaged. Coyote.

14032 w/alkaline-White C4 LED, Red, Blue, IR LEDs. Boxed.

14027 w/alkaline-White C4 LED, Red, Blue, IR LEDs w/Helmet Mount. Clam packaged. Coyote. In ROI

14031 w/alkaline-White C4 LED, Red, Blue, IR LEDs w/E-mount. Clam packaged.

Aviation Model

14008 w/alkaline-White, Green, Blue, IR LEDs. Clam packaged. Coyote.

14024 w/alkaline-White, Green, Blue, IR LEDs with MOLLE retainer. Boxed. Coyote.



SIDEWINDER® LIGHT OUTPUT & BATTERY RUN TIME

| LED | Light Output | Low 5% Output | Medium 1 25% Output | Medium 2 60% Output | High 100% Output | Strobe 100% Output |
|-------|---------------------------------|---------------|---------------------|---------------------|------------------|--------------------|
| C4* | 55 Lumens | 100 Hrs+ | 45 Hrs | 11 Hrs | 5.5 Hrs | 10 Hrs |
| IR | 25mW/sr (min) radiant intensity | 200 Hrs+ | 140 Hrs | 60 Hrs | 24 Hrs | 40 Hrs |
| Red | 1 Lumens | 200 Hrs+ | 140 Hrs | 60 Hrs | 24 Hrs | 40 Hrs |
| Blue | 1.8 Lumens | 150 Hrs+ | 100 Hrs | 35 Hrs | 16 Hrs | 30 Hrs |
| Green | 4.5 Lumens | 150 Hrs+ | 100 Hrs | 35 Hrs | 16 Hrs | 30 Hrs |

All run time to 10% of initial output level. Illumination output electronically regulated.

SIDEWINDER® RESCUE

A lightweight hands-free lighting tool with four different color LEDs, each with varying intensities for a wide variety of tasks. It features a flashing beacon that coupled with "Slide-in-Place" diffuser, projects omni-directional light to signal for help. The integrated diffuser allows you to go from tight, focused beam to wide, soft beam. Accepts either two "AA" alkaline batteries or two "AA" lithium batteries for maximum versatility in the field. IPX7 waterproof to 1 meter for 30 minutes.

SIDEWINDER RESCUE

BATTERY: (2) "AA" alkaline or (2) "AA" lithium for extended operation in extreme temperatures (-40° F to +150°F)

SIZE: 2.34" x 1.08" x 4.65"
(5.94 x 2.74 x 11.81 cm)

LITHIUM WEIGHT: 4.38 oz (124 g)

ALKALINE WEIGHT: 5.02 oz (142 g)

COLOR: Coyote

Rescue Model

14065 Kit (Aviation Model) White C4 LED, Green, Blue, IR LEDs Includes MOLLE retainer, paracord and 2 "AA" alkaline batteries. Boxed

14069 Kit (Aviation Model) White C4 LED, Green, Blue, IR LED Includes MOLLE retainer, paracord and 2 "AA" alkaline batteries. Clam

14066 w/alkaline-White C4 LED, Blue, Green, IR LEDs. Light only. Box

14067 w/alkaline-White C4 LED, Blue, Green, IR LEDs. Light only. Clam

14068 w/alkaline-White C4 LED, Blue, Green, IR LEDs. Includes E-Mount. Box



Rescue Model

- Blue LED
- IR LED
- Green LED

"Slide-in-Place" diffuser can be used with any LED color for omni-directional light

Aluminum plate provides flat surface to adhere Velcro® for attaching to helmet

Cord attachment for para-cord lanyard, which provides extra security from loss of light and allows it to be worn around the neck

Securely attaches to MOLLE or other straps using MOLLE retainer

MILITARY LIGHT IN THE WORLD.

SIDEWINDER ACCESSORIES

| Sidewinder Accessories | Sidewinder | Sidewinder Compact II |
|--|---|-----------------------|
| Helmet Mount - Coyote | 14055 | 14055 |
| Rail Mount for Helmet - Coyote | 14057 | 14057 |
| Night Vision Goggle Mount | 14135 | 14135 |
| Safety Wand - Glow in the dark | 14902 | 14902 |
| Elastic Headstrap | - | 14059 |
| E-Mount (ACH, ECH, MICH, LWH compatible) | 14136 | 14136 |
| E-Mount Access. Kit (Includes E-Mount, MOLLE Retainer and paracord) | 14137 | 14137 |
| Paracord | 14138 | 14138 |
| Sidewinder Rescue Access. Kit (Includes MOLLE Retainer and paracord) | 14139 | 14139 |
| Helmet Mount Kit-Coyote Helmet Mount, Headstrap, and MOLLE plate | 14112 | 14112 |
| Rail Mount Kit-Coyote Rail Mount, Headstrap and MOLLE plate | 14113 | 14113 |
| CR123 Batteries | 2 Pk. 85175 6 Pk. 85180 12 Pk. 85177 400 Pk. 85179 | |

SIDEWINDER COMPACT® II

Extremely versatile lighting tool with white and a variety of color LEDs for multiple tasks. Fits in the palm of your hand, clips to MOLLE vest, belt, hat brim or pocket. Helmet mount also available. Entire body rotates 185° for easy aiming of light.

Unbreakable, scratch-resistant lens. Special design for easy operation even when wearing heavy gloves. IPX7-rated waterproof to 1 meter for 30 minutes. 3 meter impact-resistance tested. O-ring and gasket-sealed for waterproof operation. Meets MIL-STD-810F, METHOD 512.4.

SIDEWINDER COMPACT II

MULTIPLE POWER SOURCES:

(1) "CR123A" lithium, or (1) "AA" Alkaline, or (1) "AA" lithium

SIZE: 3" x 1.07" x 2.04"

(7.62 x 2.72 x 5.21 cm)

WEIGHT: 2.4 oz (68 g) // 3.3 oz (94 g) w/Helmet Mount

COLOR: Coyote

Military Model

14510 White, Red, Blue, IR LEDs with Helmet Mount. Mailer.

14512 White, Red, Blue, IR LEDs with Helmet Mount. Clam.

14513 White, Red, Blue, IR LEDs with E-Mount. Clam packaged.

14514 White, Red, Blue, IR LEDs with Helmet Mount and headstrap. Mailer.

14518 White, Red, Blue, IR LEDs with Helmet and Rail Mount.

Aviation Model

14531 White, Green, Blue, IR LEDs.

14532 White, Green, Blue, IR LEDs w/Helmet Mount. Boxed.

14533 White, Green, Blue, IR LEDs with Night Vision Goggle Mount.



The Sidewinder Compact II is designed for versatility. It can operate on a "AA" Lithium, "AA" alkaline or CR123 Lithium battery.

| | C4 HIGH W/CR123 LITHIUM | C4 HIGH W/"AA" LITHIUM | C4 HIGH W/"AA" ALKALINE |
|-----------|-------------------------|------------------------|-------------------------|
| LUMENS: | 55 | 47 | 47 |
| CANDELA: | 1,175 | 1,000 | 1,000 |
| DISTANCE: | 69m | 63m | 63m |
| RUN TIME: | 6h | 6h | 2h |



Military Model
White C4® LED
Blue LED
IR/IFF LED
Red LED

Operates on a AA Alkaline, AA Lithium or CR123A Lithium battery



Aviation Model
White C4® LED
Blue LED
IR/IFF LED
Green LED

SIDEWINDER COMPACT II® BATTERY RUN TIME

| CR123 LITHIUM/"AA" LITHIUM BATTERY | | | | | |
|------------------------------------|----------------|---------------------|---------------------|------------------|--------------------|
| LED | Low 10% Output | Medium 1 25% Output | Medium 2 45% Output | High 100% Output | Strobe 100% Output |
| C4® | 70 Hrs | 28 Hrs | 16 Hrs | 6 Hrs | 10 Hrs |
| IR or Red | 100 Hrs+ | 72 Hrs | 36 Hrs | 16 Hrs | 24 Hrs |
| Blue or Green | 100 Hrs+ | 60 Hrs | 24 Hrs | 12 Hrs | 18 Hrs |
| "AA" ALKALINE BATTERY | | | | | |
| C4® | 40 Hrs | 16 Hrs | 8 Hrs | 2 Hrs | 4 Hrs |
| IR or Red | 100 Hrs+ | 48 Hrs | 18 Hrs | 9 Hrs | 14 Hrs |
| Blue or Green | 100 Hrs+ | 36 Hrs | 12 Hrs | 6 Hrs | 10 Hrs |

All run time to 10% of initial output level. Illumination output electronically regulated.

LANTERNS

SIEGE SERIES
// STREAMLIGHT 2016

SUPER SIEGE® LANTERN

| (1) WHITE C4 LED | HIGH | MEDIUM | LOW |
|------------------|-------|--------|-----|
| LUMENS: | 1,100 | 550 | 125 |
| RUN TIME: | 5h | 10.5h | 35h |

Light output with outer globe removed.

| (4) RED LEDs | HIGH | FLASH/SOS MODE | LOW |
|--------------|------|----------------|------|
| LUMENS: | 2.7 | 2.7 | 1 |
| RUN TIME: | 110h | 230h | 288h |



A small dry storage area is provided in the light's base for all your "keep dry" needs



8800 mAh rechargeable lithium ion battery supplies the power for the lantern as well as enabling you to recharge all your electronic devices from the handy USB port

NEW FOR 2016
1,100 LUMENS

The Super Siege® Lantern features five C4® power LEDs, one white and four red with six output modes and a battery level indicator built into the on/off button. An 8800 mAh rechargeable lithium ion battery supplies the power for the lantern as well as enabling you to recharge all your electronic devices from the handy USB port. With the outer lantern globe in place, the light will float. Use the lantern with or without the outer globe. Remove the outer globe and hang the body upside down by the D ring for large area lighting needs. Utilize the included "Glare Guard" to shield light from 1/2 the globe, allowing you to direct light on your work zone. A small storage area is provided in the base of the light for all your "keep dry" needs. Simply rotate the bottom cover counter clock wise to remove and access the storage compartment.

SUPER SIEGE

BATTERY: Rechargeable 8800 mAh Lithium Ion battery
SIZE: 3.8" x 7.5" (9.65 x 19.05 cm)
WEIGHT: 1 lb 14 oz (867 g)
COLOR: Coyote or Yellow

44947 Super Siege Lantern w/ AC power cord - Coyote
44945 Super Siege Lantern w/ AC power cord - Yellow

THE SIEGE: IT'S GOT
SURVIVAL
INSTINCTS.





THE SIEGE® LANTERN

SIEGE® AA LANTERN

| (4) WHITE C4 LEDs | HIGH | MEDIUM | LOW |
|-------------------|------|--------|------|
| LUMENS: | 340 | 175 | 33 |
| RUN TIME: | 30h | 70h | 295h |

Light output with outer globe removed.

| (1) RED LED | HIGH | FLASH/SOS MODE |
|------------------|------|----------------|
| LUMENS: | 10 | 10 |
| RUN TIME: | 235h | 430h |

Special Features:

- Floats for easy retrieval.
- Waterproof to 1 meter.
- 2 meter impact-resistance tested.
- Unbreakable lens.
- Rugged, non-slip base.

Versatile design features rugged carry handle and D-rings clip to hang virtually anywhere.

Shown with outer globe removed.



| WHITE C4 LED | HIGH | MEDIUM | LOW |
|------------------|------|---------|-----|
| LUMENS: | 200 | 100 | 50 |
| RUN TIME: | 7h | 15h 30m | 37h |

Light output with outer globe removed.

| (2) RED LEDs | HIGH | FLASH/SOS MODE |
|------------------|------|----------------|
| LUMENS: | .7 | .7 |
| RUN TIME: | 192h | 288h |

Special Features:

- Floats for easy retrieval.
- Waterproof to 1 meter.
- 2 meter impact-resistance tested.
- Unbreakable lens.
- Rugged, non-slip base.



The yellow Siege AA has three strong magnets in the base. It's now a versatile, hands-free work light that can be attached to steel surfaces like engines, machines, or other equipment.



The Siege is brighter, more durable, and much more versatile than other emergency/camping lanterns. It's bright enough to light up a whole campsite. It runs for over 30 hours on high, and over 12 days on low! Its handle and D-rings allow you to hang it or clip it almost anywhere, upright or inverted. It has 3 white light setting, a red light for softer, less intense light, and an SOS mode. Remove the top for brighter light. Battery indicator flashes to alert you to low battery.

THE SIEGE

BATTERY: (3) "D" size alkaline

SIZE: 3.8" x 7.25"
(9.65 x 18.41 cm)

WEIGHT: 1 lb 15 oz (878 g)

COLOR: Coyote

44931 The Siege Lantern-Coyote

The Siege® AA lantern features one C4® power LED, and two red LEDs. There are five output modes and a battery level indicator built into the on/off button. With the outer lantern globe in place, the light will float. Use the lantern with or without the outer globe cover. Remove the outer globe and hang the body upside down by the D ring for large area lighting needs. Battery indicator flashes to alert you to low battery. Battery replacement is a breeze with the center post orienting the battery cover correctly every time.

SIEGE AA

BATTERY: (3) "AA" size alkaline

SIZE: 2.37" x 5.44" (6.00 x 13.82 cm)

WEIGHT: 8.8 oz (249.47 g)

COLOR: Coyote, Yellow or Pink

44941 Siege AA Lantern-Coyote

44943 Siege AA Lantern-Yellow w/magnetic base

44944 Siege AA Lantern-Pink

SIEGE AA ACCESSORY

44942 Magnetic Base-Coyote

LIGHT UP THE WORLD ANYWHERE YOU WANT.

PORTABLE SCENE LIGHT

The Portable Scene Light provides rapid deployment on site, and it goes anywhere. With its 90° swivel neck, it's easy to shine light into the most out-of-the-way place. The head, identical to the E-Flood® HL, extends to 72" within seconds. It provides 3 levels of lighting and substantial run time to last through several shifts, even days. The unique diffuser lets you select a flood or spot beam in all three levels. It's designed to adapt to tight spaces, but rugged enough to be stable in wide open terrain or steps. The regulated light provides consistent output throughout the life of the battery. It's an indispensable tool for first responders, construction crews, and utility workers.

PORTABLE SCENE LIGHT

BATTERY: Zero-maintenance 12V, 14.4 Ah sealed lead acid. Can also be powered by 12V DC power cord.

SIZE: 22" x 6.5" x 11"
(55.88 x 16.5 x 27.9 cm)

WEIGHT: 25 lb (11.3 kg)

COLOR: Yellow

PORTABLE SCENE LIGHT

45670 120V AC/12V DC Portable Scene Light - Yellow

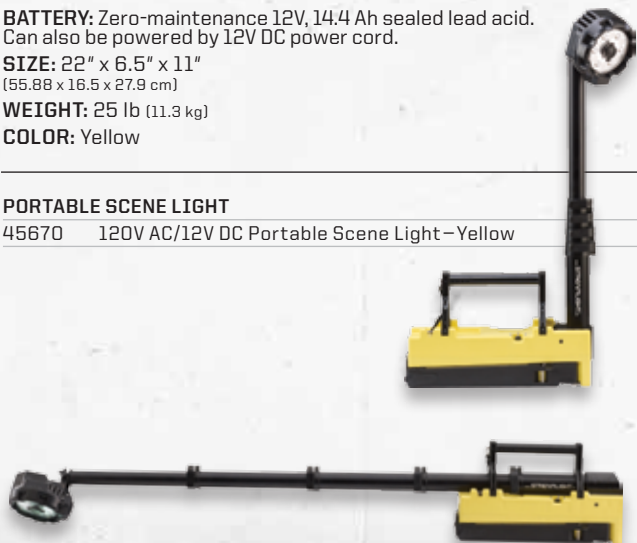

Special Features:

- Full deployment in 30 seconds
- Pole extends to 72"; cord built into the pole to avoid snags
- Stabilization legs provide balance on uneven surfaces

| | HIGH | MEDIUM | LOW |
|------------------|--------|--------|--------|
| LUMENS: | 3,600 | 2,400 | 1,100 |
| CANDELA: | 31,000 | 20,000 | 11,000 |
| DISTANCE: | 352m | 283m | 210m |
| RUN TIME: | 5h | 9h | 18h |

HL SERIES

Full extension to 72" with the stabilization legs fully deployed and locked in less than 30 seconds

Cord is built into the pole avoiding snags during deployment

Balanced design; lead acid batteries provide ballast and stability



WAYPOINT®



Trigger style switch with momentary operation.



Green Filter reduces shadows.

Red Filter preserves night vision.

Special Features:

- Unbreakable, O-ring sealed lens.
- IPX4-rated for water-resistance.
- 1 meter impact-resistance tested.
- Integrated stand for hands-free scene lighting.

550 LUMENS
NOW EVEN BRIGHTER!
MORE THAN DOUBLE THE LUMENS

| | HIGH | LOW |
|-----------|---------|-------|
| LUMENS: | 550 | 40 |
| CANDELA: | 100,000 | 7,900 |
| DISTANCE: | 625m | 178m |
| RUN TIME: | 10h | 82h |

Unlimited run time when using 12V DC power cord.
 Emergency signal run time 82 hours.

This long-distance, pistol-grip lantern is the light you need to inspect a power line from the ground, find a dock from the interior of a lake or to see whatever is way up ahead. Its beam reaches about the length of 6 football fields! It also has plenty of peripheral light, so you can see what's all around you. Set it down to illuminate an entire area or aim it to check on trees or power lines far away. This next generation alkaline model features 3 modes including a strobe for signaling.

WAYPOINT

BATTERY: 4 "C" batteries (not included).
 Can also be powered by 12V DC power cord (included)

SIZE: 6.75" x 7.14" x 3.5"
 (17.15 x 18.14 x 8.89 cm)

WEIGHT: 1 lb 12.8 oz (816 g)

COLOR: Yellow or Black

| YELLOW | BLACK | |
|--------|-------|--|
| 44900 | 44902 | 12V DC power cord* - w/polymer storage mount |
| 44904 | 44905 | 12V DC power cord* |

ACCESSORIES

| | | |
|-------|-------|-----------------------|
| 44908 | 44908 | Polymer Storage Mount |
| 44903 | 44903 | 12V DC power cord* |
| 44924 | 44924 | Red Filter |
| 44925 | 44925 | Green Filter |

*12V DC power cord does not recharge batteries

WAYPOINT® RECHARGEABLE

The rechargeable model has a broader, wider beam than the original Waypoint. It spreads bright light across a whole room, campsite or backyard illuminating everything, yet its beam still reaches an impressive 678 meters. IPX8 rated design waterproof to 2 meters. Light floats if dropped in water. Includes 3 modes: low, medium and high. With its integrated stand you can set it up for easy area illumination. Fully recharges in 4 hours.

WAYPOINT RECHARGEABLE

BATTERY: Lithium Ion with on-board safety control circuit

SIZE: 6.75" x 7.14" x 3.62" (17.15 x 18.14 x 9.29 cm)

WEIGHT: 1 lb 8.32 oz (691 g)

COLOR: Yellow or Black

| YELLOW | BLACK | |
|--------|-------|--------------------------|
| 44910 | 44911 | with 120V AC charge cord |

ACCESSORIES

| | | |
|-------|-------|-----------------------|
| 44918 | 44918 | Polymer Storage Mount |
| 44915 | 44915 | Red Filter |
| 44916 | 44916 | Green Filter |
| 44923 | 44923 | 12V DC charge cord |
| 44909 | 44909 | 120V AC charge cord |

Green Filter reduces shadows.

Red Filter preserves night vision.



The Waypoint rechargeable holder allows for secure storage (included with product and also offered as an accessory).



Special Features:

- Unbreakable, O-ring sealed lens.
- IPX8-rated for water-resistance.
- 1 meter impact-resistance tested.
- Integrated stand for hands-free scene lighting.



Includes 120V Charge Cord.

1,000 LUMENS
NOW EVEN BRIGHTER!
MORE THAN DOUBLE THE LUMENS

| | HIGH | MEDIUM | LOW |
|-----------|---------|--------|--------|
| LUMENS: | 1,000 | 550 | 35 |
| CANDELA: | 115,000 | 60,000 | 10,000 |
| DISTANCE: | 678m | 490m | 200m |
| RUN TIME: | 3h | 6h | 80h |

NON-RECHARGEABLE

LIGHTS FOR A CAUSE SERIES
// STREAMLIGHT 2016

STREAMLIGHT CARES: THE PRODUCTS THAT ALLOW YOU TO SUPPORT CAUSES THAT MATTER.

STRION® LED

PROTAC HL®

SIEGE® AA LANTERN



C4 LED With **[(STROBE)]**
Double tap switch to activate.

| | HIGH | MEDIUM | LOW |
|------------------|--------|--------|--------|
| LUMENS: | 260 | 130 | 65 |
| CANDELA: | 10,000 | 5,000 | 2,500 |
| DISTANCE: | 200m | 141m | 100m |
| RUN TIME: | 2h | 4h | 7h 30m |

A powerful value that's perfect for the broadest range of lighting needs. IPX4-rated for water-resistance. Adjustable ring provides a sure-grip for easy one-handed operation. 2 meter impact-resistance tested.

STRION LED

BATTERY: Lithium-ion with on-board safety control circuit

SIZE: 5.9" x 1.25" x .95"
(14.99 x 3.18 x 2.41 cm)

WEIGHT: 5.2 oz (148 g)

COLOR: Pink

74350 with AC/12V DC-1 Holder. Pink.



For every pink Strion® LED sold, Streamlight will donate \$5 to the Breast Cancer Research Foundation.®

The Breast Cancer Research Foundation® is an independent 501 (c) (3) not-for-profit organization whose mission is to achieve prevention and a cure for breast cancer in our lifetime by providing critical funding for innovative clinical and genetic research at leading medical centers worldwide, and increasing public awareness about good breast health. For more information, visit www.bcrfure.org.



Nylon
Holster

HL SERIES

HL **C4 LED** With **[(STROBE)]**
Double tap switch to activate.

| | HIGH | LOW |
|------------------|--------|-----|
| LUMENS: | 600 | 33 |
| CANDELA: | 16,000 | 800 |
| DISTANCE: | 253m | 57m |
| RUN TIME: | 1h 15m | 18h |

Strobe runs 2.5 hours

One of the brightest tactical personal carry lights of its size. Far-reaching beam. TEN-TAP® programming lets you choose the order of operating modes (high, low, strobe). IPX7-rated water-proof to 1 meter/30 minutes. 1 meter impact-resistance tested.

PROTAC HL

BATTERY: (2) 3V "CR123A" lithium

SIZE: 5.4" x 1.375" x 1.0"
(13.72 x 3.49 x 2.54 cm)

WEIGHT: 5.6 oz (158 g)

COLOR: Pink

88044 with lithium batteries and holster. Pink.



For every pink ProTac® HL sold, Streamlight will donate \$3 to the Breast Cancer Research Foundation.®

The Breast Cancer Research Foundation® is an independent 501 (c) (3) not-for-profit organization whose mission is to achieve prevention and a cure for breast cancer in our lifetime by providing critical funding for innovative clinical and genetic research at leading medical centers worldwide, and increasing public awareness about good breast health. For more information, visit www.bcrfure.org.

| WHITE C4 LED | HIGH | MEDIUM | LOW |
|------------------|------|---------|-----|
| LUMENS: | 200 | 100 | 50 |
| RUN TIME: | 7h | 15h 30m | 37h |

Light output with outer globe removed.

| (2) RED LEDs | HIGH | FLASH/SOS MODE |
|------------------|------|----------------|
| LUMENS: | .7 | .7 |
| RUN TIME: | 192h | 288h |



With **[(RED SOS)]**
Hold on/off button to activate.

Shown with
outer globe
removed.



The Siege® AA lantern features one C4® power LED, and two red LEDs. There are five output modes and a battery level indicator built into the on/off button. With the outer lantern globe in place, the light will float. Use the lantern with or without the outer globe cover. Remove the outer globe and hang the body upside down by the D ring for large area lighting needs. Battery replacement is a breeze with the center post orienting the battery cover correctly every time.

SIEGE AA

BATTERY: (3) "AA" size alkaline

SIZE: 2.37" x 5.44"
(6.00 x 13.82 cm)

WEIGHT: 8.8 oz (249.47 g)

COLOR: Pink

44944 Siege AA Lantern - Pink



For every pink Siege AA sold, Streamlight will donate \$2 to the Breast Cancer Research Foundation.®

The Breast Cancer Research Foundation® is an independent 501 (c) (3) not-for-profit organization whose mission is to achieve prevention and a cure for breast cancer in our lifetime by providing critical funding for innovative clinical and genetic research at leading medical centers worldwide, and increasing public awareness about good breast health. For more information, visit www.bcrfure.org.

NANO LIGHT®



LUMENS: 10
RUN TIME: 8h

This tiny, weatherproof light has a non-rotating snap hook for easy one-handed operation when attached to a keychain.

NANO

BATTERY: (4) alkaline button cell

SIZE: 1.47" x .51" x .43"
(3.73 x 1.3 x 1.09 cm)

WEIGHT: .36 oz (10 g)

COLOR: Black, Blue, Pink, Red, Orange or Coyote

| | |
|-------|---------------------------------------|
| 73001 | Black with White LED |
| 73002 | COPS/Blue with White LED |
| 73003 | BCRF/Pink with White LED |
| 73005 | NFFF/Red with White LED |
| 73006 | BADF/Orange with White LED |
| 73007 | TMF/Coyote with White LED |
| 73008 | ADA/Red with White LED |
| 61205 | 4 pack coin cell Nano Light Batteries |

For each color Nano Light sale, we donate \$1 to the organization associated with that light. Look to the right for information about each cause.



By purchasing this product you are helping to make a difference in the rebuilding of the lives of surviving families and affected co-workers of law enforcement officers killed in the line of duty. In addition to rebuilding lives, C.O.P.S. provides training to law enforcement agencies on survivor victimization issues and educates the public of the need to support the law enforcement profession and its survivors. For more information, visit www.nationalcops.org.



The Breast Cancer Research Foundation® is an independent 501 (c) (3) not-for-profit organization whose mission is to achieve prevention and a cure for breast cancer in our lifetime by providing critical funding for innovative clinical and genetic research at leading medical centers worldwide, and increasing public awareness about good breast health. For more information, visit www.bcrfcure.org.



Congress created the National Fallen Firefighters Foundation to lead a nationwide effort to honor America's fallen firefighters. Since 1992, the non-profit foundation has developed and expanded programs that fulfill that mandate. Their mission is to honor and remember America's fallen fire heroes and to provide resources to assist their survivors in rebuilding their lives. For more information, visit www.firehero.org.



The Buckmasters American Deer Foundation, (BADF), founded by Jackie Bushman was born from the desire to give back to the hunting community, starting with programs such as Project Venison and Hunters of Tomorrow. Buckmasters Chapters from across the country continue to give to those in need. For more information, visit www.buckmasters.com/resources/badf.aspx.



The Travis Manion Foundation honors and assists our nation's veterans, first responders, and the families of fallen heroes through various grants, scholarships, races, and The annual 9/11 Heroes Run. For more information, visit www.travismanion.org.



By purchasing this product, you are helping to make a difference in lives of those affected by diabetes. The mission of The American Diabetes Association is to prevent and cure diabetes and improve the lives of all people affected by diabetes. To learn more, please visit www.diabetes.org.



Streamlight, Inc.
30 Eagleville Road
Eagleville, PA U.S.A. 19403-3996

@2016 Streamlight, Inc. ISO 9001:2008 certified 990316 1/16 asi/89871

// **STAY CONNECTED WITH US:**



All rights reserved. Trademarks of companies mentioned herein appear for identification purposes only and are the property of their respective companies.